

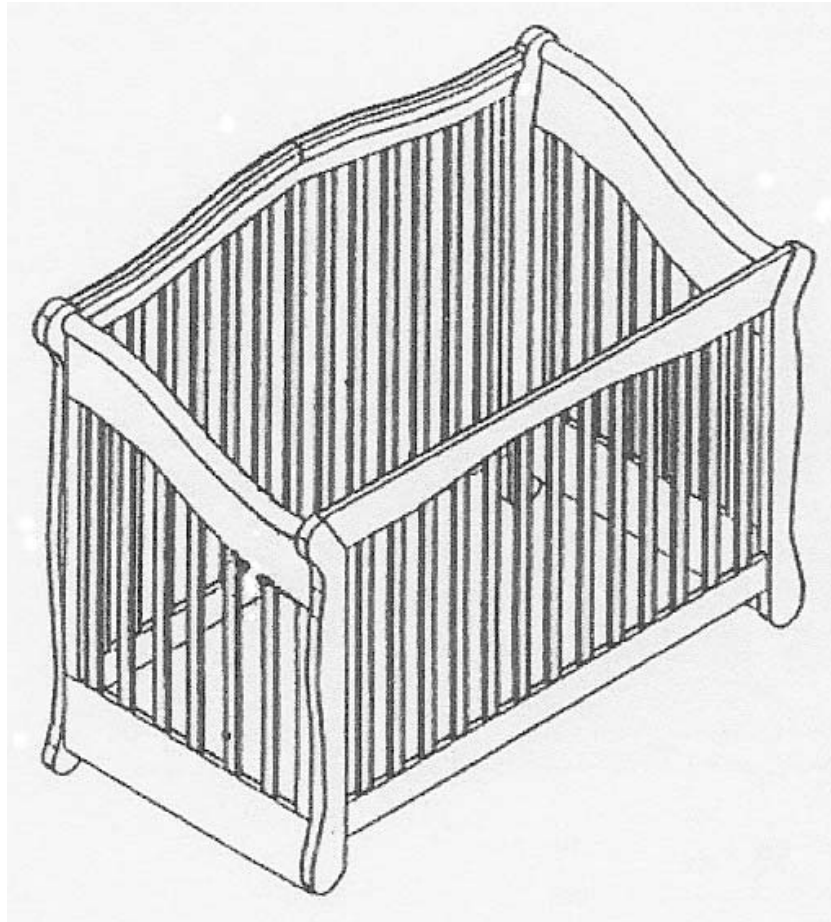

Model # BELLA

14 Brisbane Rd. Toronto, ON Canada M3J 2J8
Tel.: (416) 661-8201; Fax: (416) 661-3305
www.mhcfurniture.com



**CANADIAN
REGULATIONS**



**REGLEMENTATIONS
CANADIENNES**

DO NOT REMOVE THIS POUCH FROM SPRING UNIT!
AFTER CRIB HAS BEEN COMPLETELY
ASSEMBLED, STORE INSTRUCTION SHEET IN THIS
POUCH FOR FUTURE REFERENCE.

NE PAS RETIRER CE SACHET OU RESSORT OU LIT!
APRES L'ASSEMBLAGE COMPLET DU LIT,
CONSERVEZ CETTE NOTICE D'UTILISATION DANS
CE SACHET.

WARNING

- ✦ Do not use this crib if the enclosed or attached instructions cannot be strictly adhered to.
- ✦ Do not use this crib if the child is able to climb out unaided or is taller than 90 cm (35 inches).
- ✦ Do not place cords, straps or similar items that could become wound around the child's neck in or near this crib.
- ✦ Ensure that the sides are properly latched or locked in place when the crib is occupied.
- ✦ The mattress used with this crib should not be more than 15 cm (6 inches) thick and should be of such length and width that gap between the mattress and the sides of the crib is not more than 3 cm (1 1/4 inches) when the mattress is pushed into the corner of the crib.

MISE EN GARDE

- ✦ Ne pas utiliser le lit d'entant à moins d'etre en mesure de respecter rigoureusement le mode d'emploi ci-joint ou apposé sur le produit.
- ✦ Ne pas utiliser le lit d'enfants si l'enfant est capable d'en sortir sans aide ou si l'enfant mesure plus de 90 cm (35 puces).
- ✦ Ne pas mettre dans le lit, ou à proximité du lit des cordes courroies ou objets semblables qui pourraient s'enrouler autour du cou de l'enfant.
- ✦ S'assurer que les cotes sont bien enclenches ou verrouilles lorsque l'enfant est place dans le lit.
- ✦ L'épaisseur du matelas utilise dans le lit ne doit pas être supérieure à 15 cm (6 pouces) et sa longueur et sa largeur doivent être telles que l'espace entre le matelas et les cores au lit ne soit pas superieur a 3 cm (1 1/4 pouce) lorsque le matelas est pousse dans un des coins.



UNITED STATES REGULATIONS

IMPORTANT: DO NOT REMOVE THIS POUCH FROM SPRING UNIT!
AFTER CRIB HAS BEEN COMPLETELY ASSEMBLED, STORE INSTRUCTION SHEET IN THIS POUCH.

WARNING

FAILURE TO FOLLOW THIS WARNINGS AND ASSEMBLY INSTRUCTIONS COULD RESULT IN SERIOUS INJURY OR DEATH.
BEFORE EACH USAGE OR ASSEMBLY, INSPECT CRIB FOR DAMAGED HARDWARE, LOOSE JOINTS, MISSING PARTS OR SHARP EDGES. DO NOT USE CRIB IF ANY PARTS ARE MISSING OR BROKEN, ASK YOUR DEALER FOR REPLACEMENT PARTS AND INSTRUCTIONAL LITERATURE IF NEEDED. DO NOT SUBSTITUTE PARTS.
AFTER RAISING SIDE, MAKE SURE LATCHES ARE SECURE.
WHEN CHILD IS ABLE TO CLIMB OUT OR REACHES THE HEIGHT OF 35 IN. (90 CM), THE CRIB SHALL NO LONGER BE USED.
DO NOT PLACE CRIB NEAR WINDOW WHERE CORDS FROM BLINDS OR DRAPES MAY STRANGLE A CHILD, IF REFINISHING, USE A NON-TOXIC FINISH SPECIFIED FOR CHILDREN'S PRODUCTS.
DO NOT USE A WATER MATTRESS WITH THIS CRIB.

CAUTION: ANY MATTRESS USED IN THIS CRIB MUST BE AT LEAST 27 1/4 BY 51 5/8 INCHES WITH A THICKNESS NOT EXCEEDING 6 INCHES.

Mother Hubbard's Cupboards

14 Brisbane Rd. Toronto, ON Canada M3J 2J8

Tel.: (416) 661-8201; Fax: (416) 661-3305

www.mhcfurniture.com**CRIB ASSEMBLY INSTRUCTIONS**

Thank you for selecting a **MOTHER HUBBARD'S CUPBOARDS** product.

To ensure the best performance from your crib, please read these instructions carefully. If you have any questions or concerns, notify us and we will gladly assist you.

Due to weather patterns and nature, no two trees are alike. One tree can vary in texture, grains and density. This causes the acceptance of stains and sealers to vary. This is the mystery of wood. Knots, blemishes and swirls can appear. These patterns are the elegance and beauty of wood.

Even though we make every effort to bring you the very best style and quality, there will be instances where nature, and not man will decide the look of your furniture.

Carefully remove and lay out all parts. Familiarize yourself with all diagrams. Parts enclosed in hardware bag should correspond with the parts list. Be sure all parts are included, and quantities are correct. You will need a flat head screwdriver, a pair of pliers, Phillips head screwdriver, Alien key, hammer and a small piece of wood.

CLEANING

Mix a mild dishwasher liquid and water solution, apply to crib surface with a soft cloth lightly dampened in the solution. After cleaning, dry all surfaces thoroughly with a soft dry cloth. No abrasive cleaners, scouring pads, steel wool or coarse rags should be used to clean this furniture.

WARNING

Your child's safety is important, please read the safety warning

- Parents should ensure a safe environment for the child by regularly checking that every component is securely in place **BEFORE** placing the child into the crib.
- **NEVER** use plastic shipping bags or other plastic films as mattress covers because they can cause suffocation.
- Infants can suffocate in gaps between crib sides and a mattress that is too small.

WARNING! Infants can suffocate on soft bedding. **Never** add a pillow or comforter.

- **Never** place additional padding under an infant.
- To reduce the risk of SIDS, pediatricians recommend healthy infants to be placed on their backs to sleep, unless otherwise advised by your physician.
- To help prevent strangulation tighten all fasteners. A child can trap parts of the body or clothing on loose fasteners
- Follow warnings on all products in a crib.

Before each usage or assembly, inspect the crib for damaged hardware, loose joints, missing parts, or sharp edges. **DO NOT** use the crib if any parts are missing or broken. Contact your dealer or **MOTHER HUBBARD'S CUPBOARDS** for replacement parts and/or instructional literature.

DO NOT substitute parts.

Upon completion of assembly be sure all screws, bolts and fastening devices have been tightened securely. Be sure to do a periodic check to ensure this.

KEEP ASSEMBLY INSTRUCTIONS WITH YOUR CRIB FOR FUTURE REFERENCE

SUBASSEMBLIES & PARTS

IMPORTANT NOTE: THESE ASSEMBLY INSTRUCTIONS APPLY TO ALL CRIBS MANUFACTURED BY OUR COMPANY, THEREFORE THE ILLUSTRATIONS MAY NOT REPRESENT YOUR SPECIFIC MODEL.

BACK SIDE

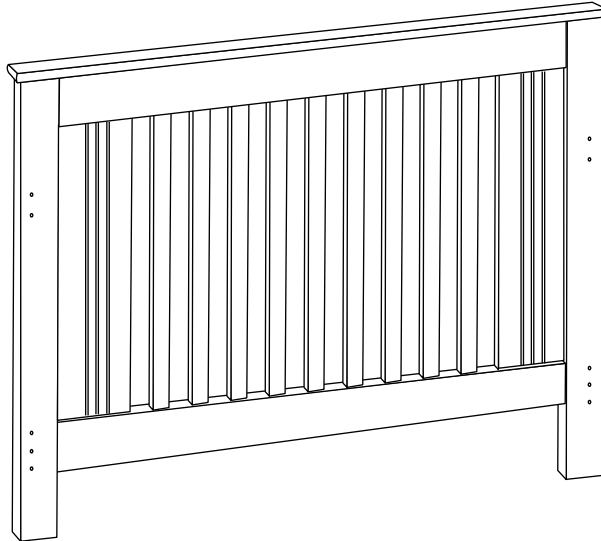

RIGHT SIDE BOARD

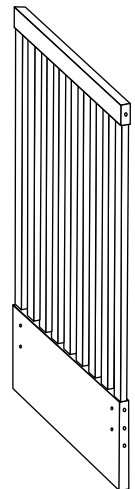

LEFT SIDE BOARD

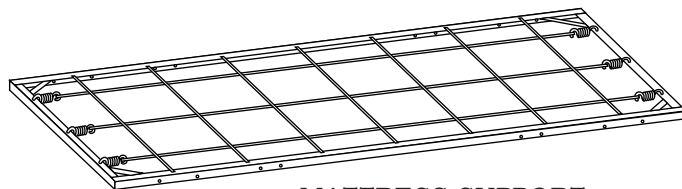
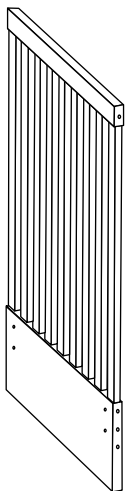

MATTRESS SUPPORT

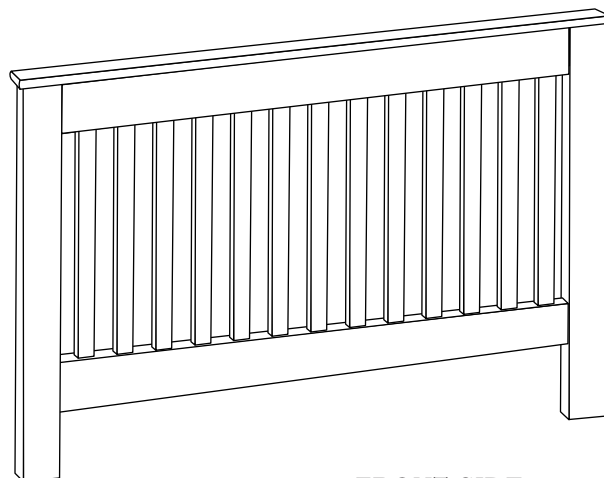

FRONT SIDE

HARDWARE



BOLT #1 - 6 x 40mm

4 pcs

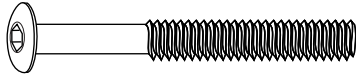

BOLT #2 - 6 x 50mm

2 pcs

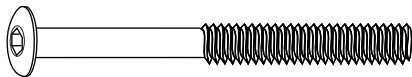

BOLT #3 - 6 x 60mm

8 pcs



LOCKING WASHER

4 pcs

NECESSARY TOOLS

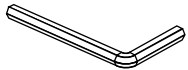

ALLEN WRENCH

WARNING

Before each usage or assembly, inspect the crib for damaged hardware, loose joints, missing parts or sharp edges.

DO NOT use crib if any parts are missing or broken. Contact your dealer, or Mother Hubbard's Cupboards furniture.

STEP 1 First align the hole on the top of the Side panel with the hole in on the top of the Back panel. Using Bolt #2 attach the Side panels to the Back Side. Then, using Bolt #3 complete the assembly (as shown). Use the same technic for the other Side panel.

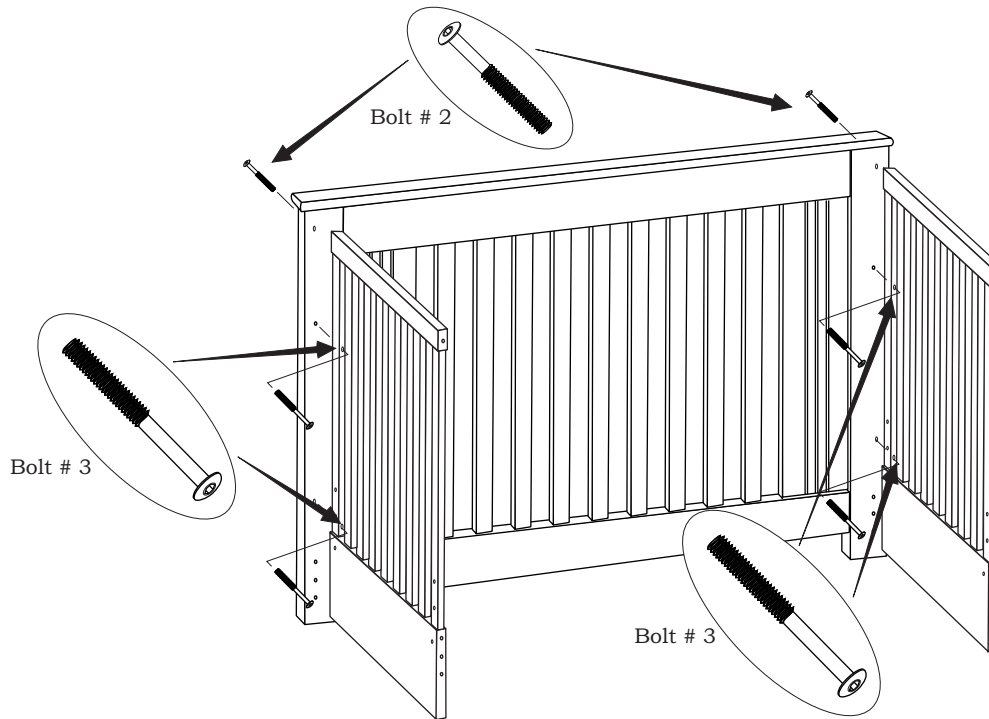

STEP 2 Attach the Mattress Support to it's designated holes on the Side Panels. Choose the desired height. Insert Bolt #1 through the Locking Washer and then into the hole on the Side Panel. Match it to the threaded holes on the Mattress Support's frame. Use the provided Allen key and **FULLY TIGHTEN**

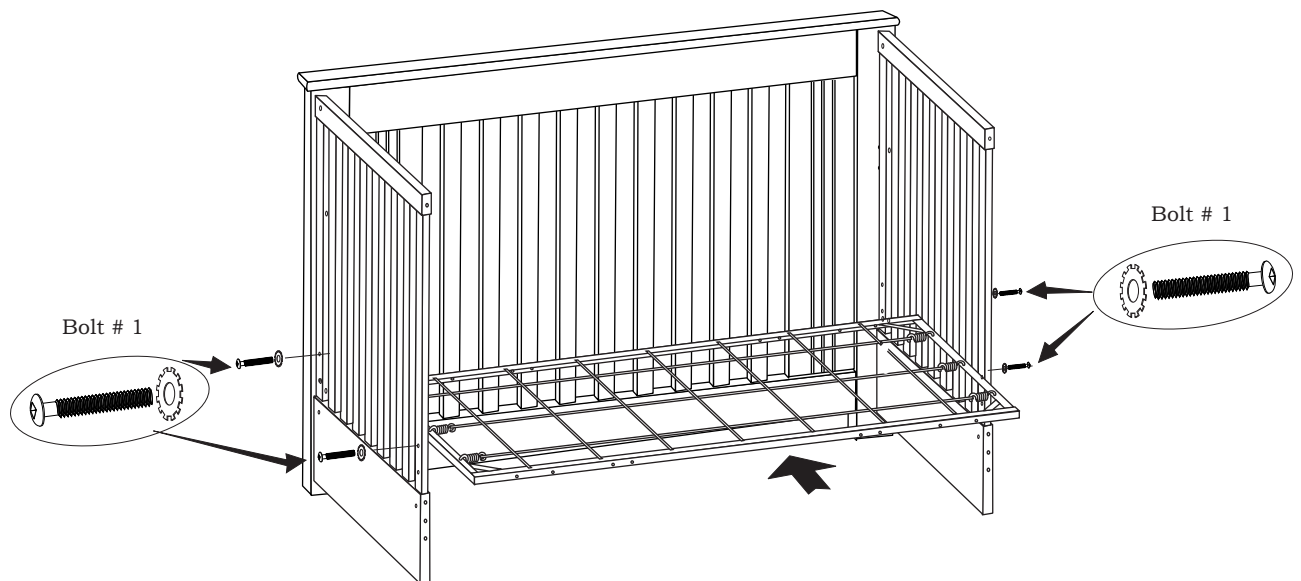

STEP 3 To attach the Front Side to the Side panels, first insert the remaining four Bolts #3 into the holes on the front railing of the Side panels (Left and Right). Align the receiving hole of the Front Side with the Bolts from the Side Panels and tighten the Bolts using the provided Allen key. Revisit and carefully tighten all bolts.

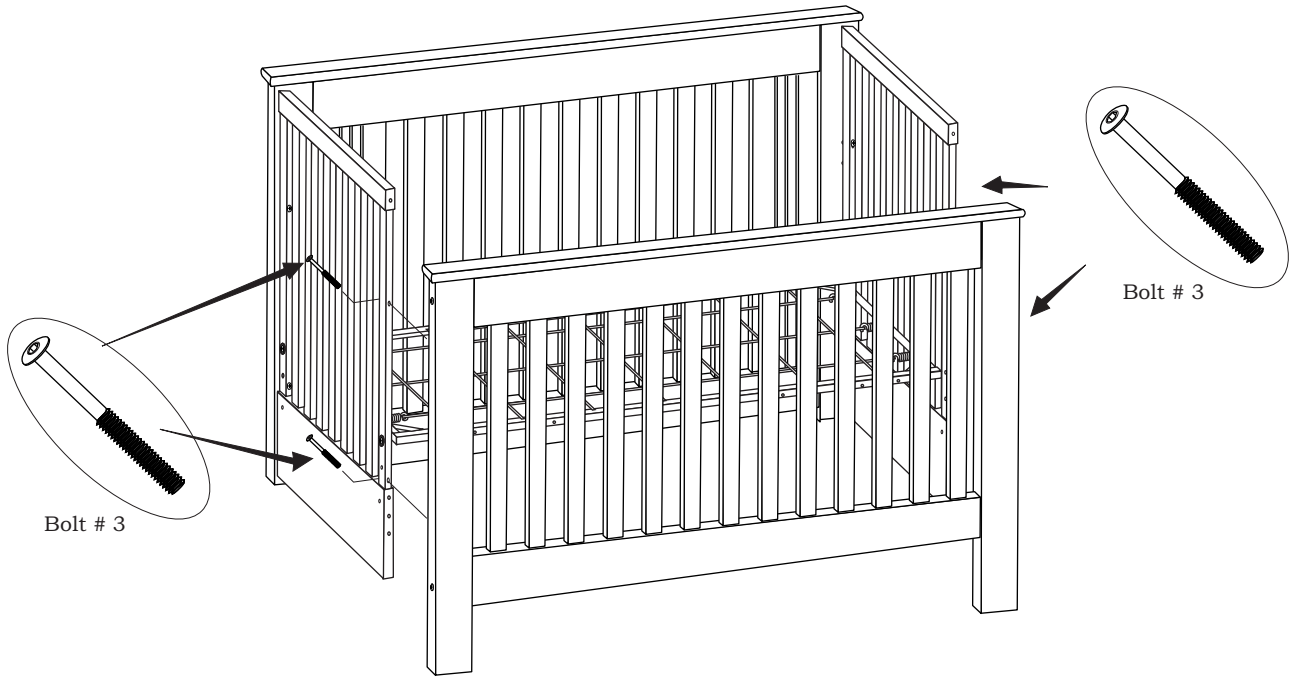

Option 1 If the removal of the front railing is desired, using the Allen key, withdraw the Bolts from the side of the legs of the Front Side as shown. Then remove the front railing subassembly.

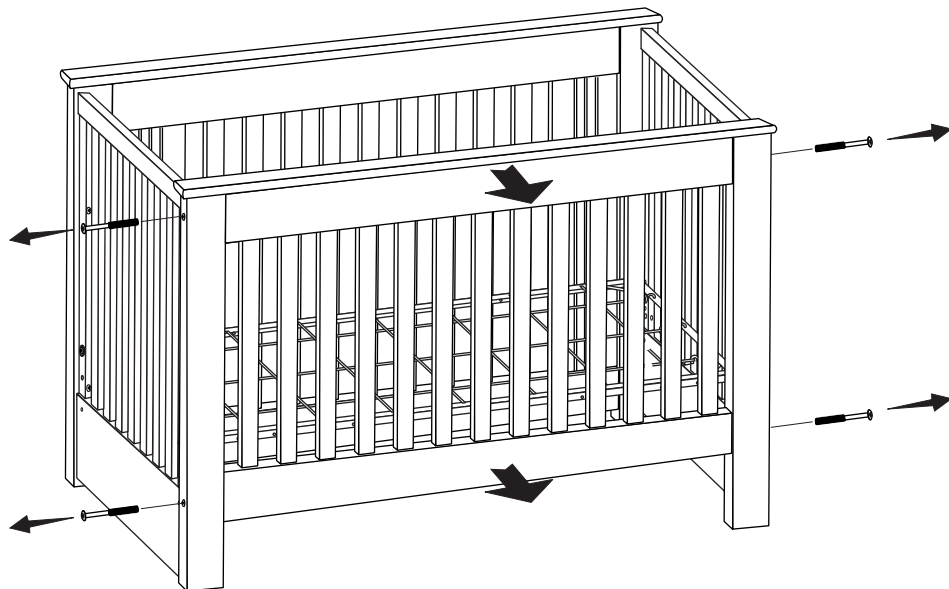

Option 2 Using it as a Full Bed (Full bed kit sold separately)

Withdraw the Bolts#2 and Bolts#3 from the Side panels (Left and Right). From the front as well as from the back. This will free the Front Side and the Back Side.

Install the full bed Kit using the hardware that comes with it, to obtain the frame shown on the lower illustration.

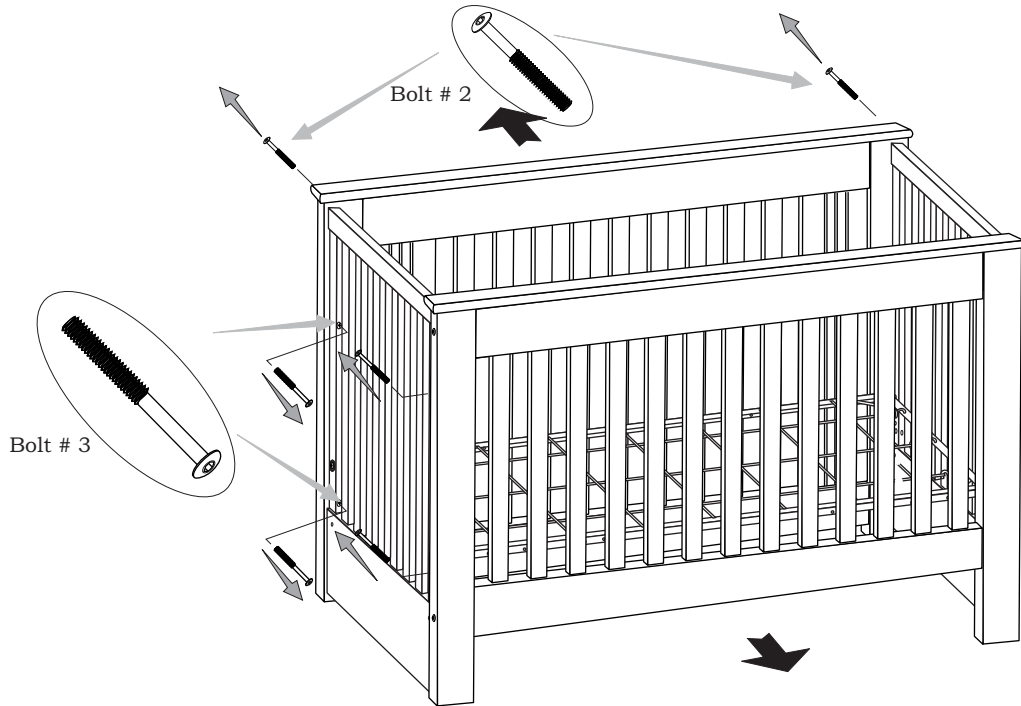

See the conversion instructions inside the conversion Kit.

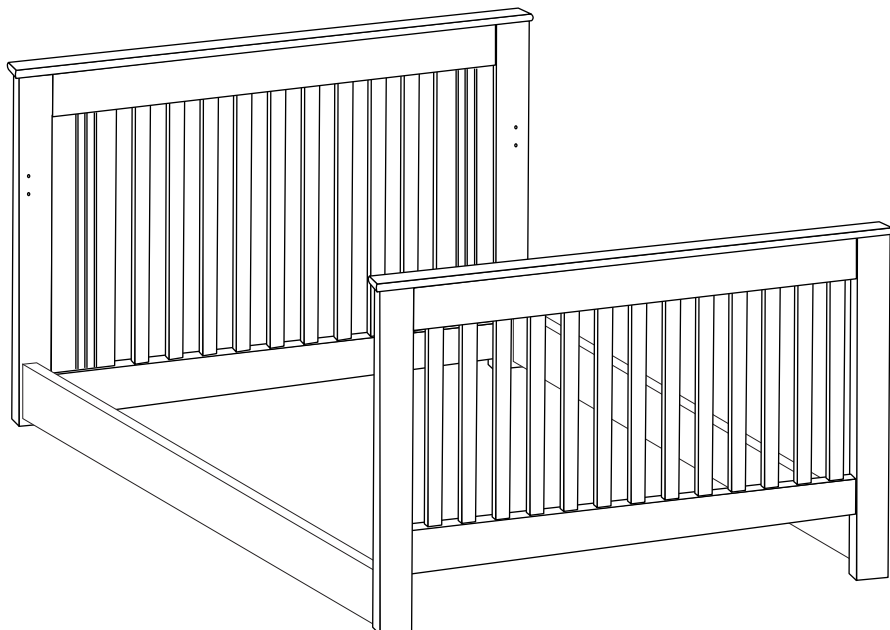

WARNING**FAILURE TO FOLLOW THESE WARNINGS AND ASSEMBLY INSTRUCTIONS
COULD RESULT IN SERIOUS INJURY AND DEATH**

- Always ensure a safe environment for the child. Check that every component is properly secured and in place, before placing the child in the crib.
- The crib has an adjustable spring, which serves as a mattress support. For the convenience of the mother when the baby is very small, the spring may be used in the highest position.
- After raising side, make sure latches are secure!
- **IMPORTANT** - With the spring and mattress in their highest position and the mobile frame in the lowered position, be absolutely sure the top of the drop-side is at least 3 inches (7.6 cm) higher than the top surface of mattress. If it is not, lower the spring and mattress to the next highest position and check again.
- When your child is beginning to push up on its hands and knees or is 5 month of age, whichever occurs first, remove all toys which are strung across crib area. These toys cause STRANGULATION!
- When your child is able to pull into a standing position, set the mattress to it's lowest position and remove bumper pads, larger toys and other objects that could serve as steps for climbing our.
- When the child is able to climb out, or reaches the height of 35 inches (90centimeters), the crib should no longer be used. The child should then be placed in a youth or regular bed.
- Strings can cause strangulation! DO NOT place items with a string around the child's neck, such as hood strings or pacifier cords. DO NOT suspend strings over crib or attach strings to toys.
- Any mattress used in the crib must be at least 27 1/4 inches (69 centimeters), by 51 5/8 inches (131 centimeters) with a thickness not exceeding 6 inches (15 centimeters). The dimensions of mattress shall be taken from seam to seam or edge to edge where appropriate.
- Never use plastic shipping bags or plastic film as mattress, covers because they can cause suffocation.
- **DO NOT** place crib near window where cords from blinds or drapes may strangle a child.
- **DO NOT** place the child in crib with drop-side down. Be sure mobile frame is raised and in locked position whenever the child is in the crib.
- **DO NOT** use a water mattress with this crib.
- Contact Mother Hubbard's Cupboards for replacement parts and instructional literature if Needed.
- When disassembling this crib, **DO NOT** remove any item attached with wood screws.
- If refinishing, use a non-toxic finish specified for children's products.
- Use a vaporizer near furniture will cause the wood to swell and finish to peel.